

Y2 Y3做脉冲方向时，继电器输出那里请不要使用。

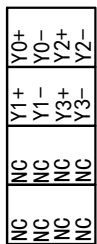

此处为5V
差分信号输出

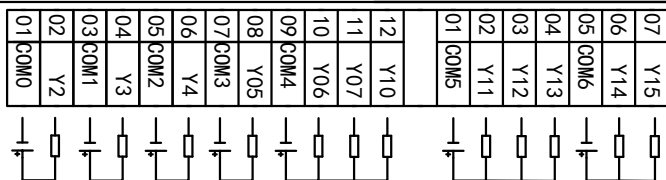

MC-24MR-4MTS-F500-FX-A

- PLC运行开关
- PLC下载口 USB COM1
- 触摸屏下载口



触摸屏系统按键

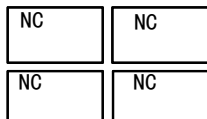
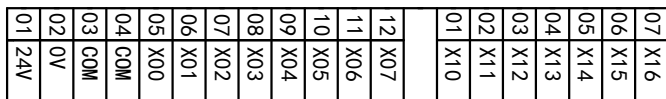
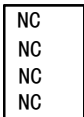

直流24V电源输入

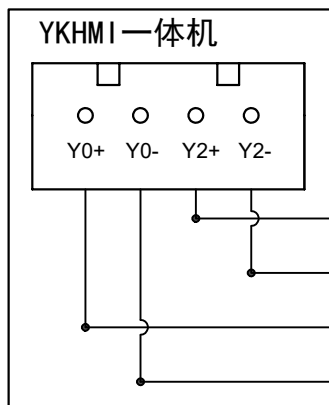
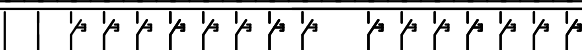

中间不用电阻



产品合格证

生产日期		检验结论	合格	检验员	
------	--	------	----	-----	--