

# MM-20MR-8MTS-F420-H3U-B接线图

输入属于NPN型，不需要外接电源，直接短接COM和X点即可

屏幕型号: F420  
plc型号: FX3U

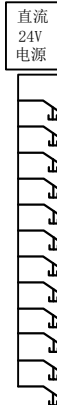

00	24V
01	0V
02	COM
03	X00
04	X01
05	X02
06	X03
07	X04
08	X05
09	X06
10	X07
11	X10
12	X11
13	X12
14	X13

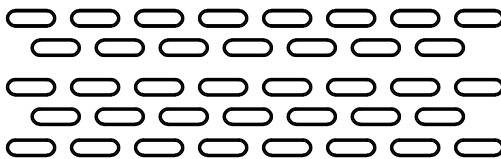

00	COM0
01	Y10
02	Y11
03	Y12
04	Y13
05	COM1
06	Y14
07	Y15
08	Y16
09	Y17

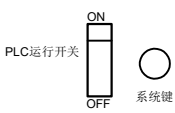
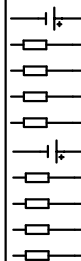

Y0+	Y1+	Y2+	Y3+
Y0-	Y1-	Y2-	Y3-
Y4+	Y5+	Y6+	Y7+
Y4-	Y5-	Y6-	Y7-

此处为5V增强信号

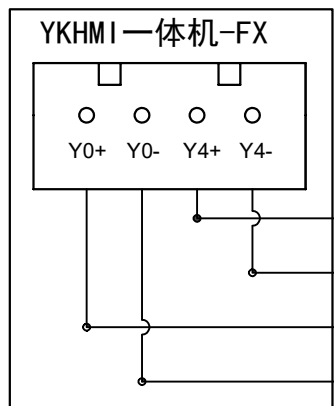
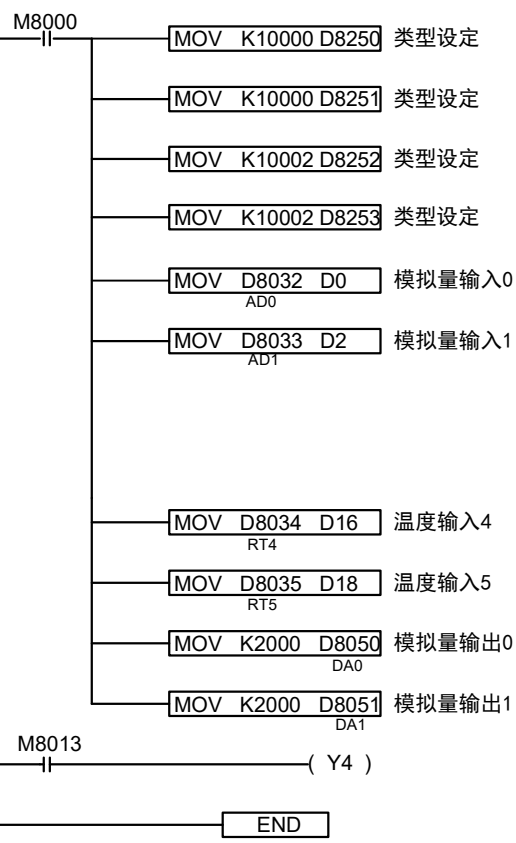

中间不用电阻

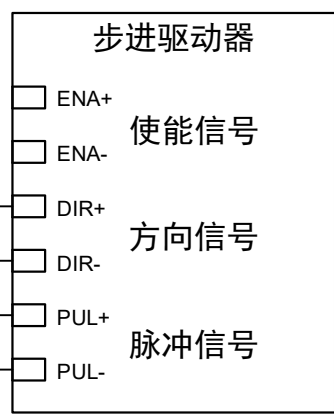

产品合格证

生产日期		检验结论	合格	检验员
------	--	------	----	-----